

IGBT MODULE (F series)

■ Features

- Low Saturation Voltage
- Voltage Drive
- Variety of Power Capacity Series

■ Applications

- Inverter for Motor Drive
- AC and DC Servo Drive Amplifier
- Uninterruptible Power Supply
- Industrial Machines, such as Welding Machines

■ Maximum Ratings and Characteristics

● Absolute Maximum Ratings

Items	Symbols	Ratings	Units
Collector-Emitter Voltage	V_{CES}	600	V
Gate-Emitter Voltage	V_{GES}	± 20	V
Collector Current	Continuous	I_C	200
	1ms	$I_{C,pulse}$	400
	Continuous	$-I_C$	200
	1ms	$-I_{C,pulse}$	400
Max. Power Dissipation	P_C	720	W
Operating Temperature	T_j	+150	$^{\circ}C$
Storage Temperature	T_{stg}	-40 to +125	$^{\circ}C$
Net. Weight		340	g
Isolation Voltage	AC. 1min.	V_{isol}	2500
Screw Torque	Mounting *1	3.5 {35}	N · m
	Terminals *1	3.5 {35}	{kg · cm}

*1 Recommendable Value 2.5 to 3.5 N·m {25 to 35 kg·cm} (M5)

● Electrical Characteristics (T_c=25 $^{\circ}C$)

Items	Symbols	Test Conditions	Min.	Typ.	Max.	Units
Zero Gate Voltage Collector Current	I_{CES}	$V_{GE}=0V$ $V_{CE}=600V$ $T_j=25^{\circ}C$			2.0	mA
		$V_{GE}=0V$ $V_{CE}=600V$ $T_j=125^{\circ}C$			—	mA
Gate-Emitter Leakage Current	I_{GES}	$V_{CE}=0V$ $V_{GE}=\pm 20V$			200	nA
Gate-Emitter Threshold Voltage	$V_{GE(th)}$	$V_{CE}=20V$ $I_C=200mA$	3.0		6.0	V
Collector-Emitter Saturation Voltage	$V_{CE(sat)}$	$V_{GE}=15V$ $I_C=200A$			2.5	V
Input Capacitance	C_{ies}	$V_{GE}=0V$		19000		pF
Output Capacitance	C_{oes}	$V_{CE}=10V$		—		
Reverse Transfer Capacitance	C_{res}	$f=1MHz$		—		
Turn-on Time	t_{on}	$V_{CC}=300V$			0.8	μs
	t_r	$I_C=200A$			0.6	
Turn-off Time	t_{off}	$V_{GE}=\pm 15V$			1.5	
	t_f	$R_G=9.1\Omega$			1.0	
Diode Forward On-Voltage	V_F	$I_F=200A$, $V_{GE}=0V$			2.5	V
Reverse Recovery Time	t_{rr}	$I_F=200A$, $-di/dt=600A/\mu s$ $V_{GE}=-10V$			300	ns

● Thermal Characteristics

Items	Symbols	Test Conditions	Min.	Typ.	Max.	Units
Thermal Resistance	$R_{th(j-cl)}$	IGBT			0.174	$^{\circ}C/W$
	$R_{th(j-cl)}$	Diode			0.333	
	$R_{th(c-f)}$	With Thermal compound		0.025		

■ Outline Drawings

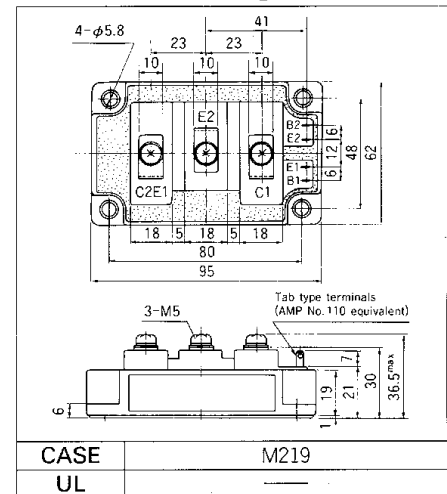

■ Equivalent Circuit Schematic

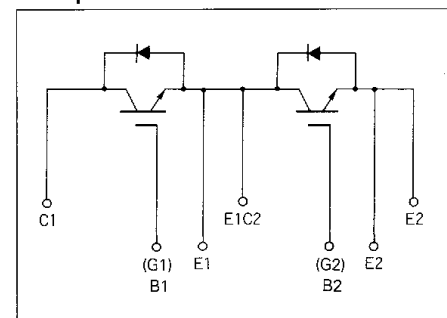

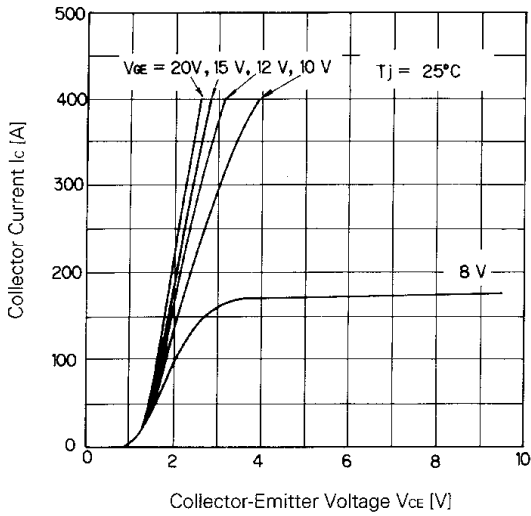

Collector Current vs. Collector-Emitter Voltage

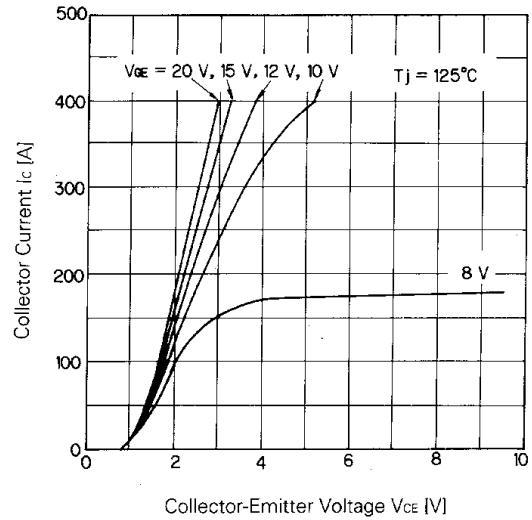

Collector Current vs. Collector-Emitter Voltage

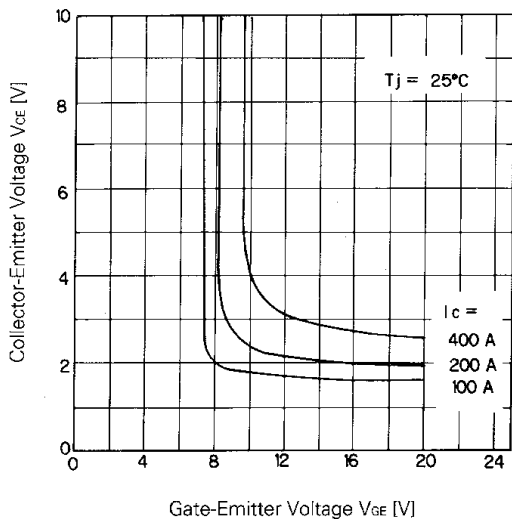

Collector-Emitter Voltage vs. Gate-Emitter Voltage

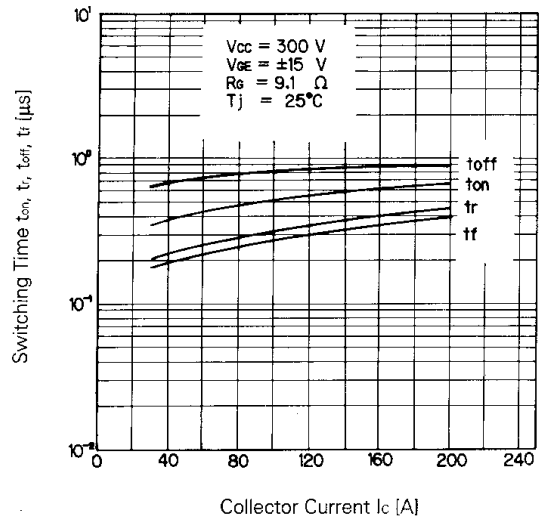

Switching Time

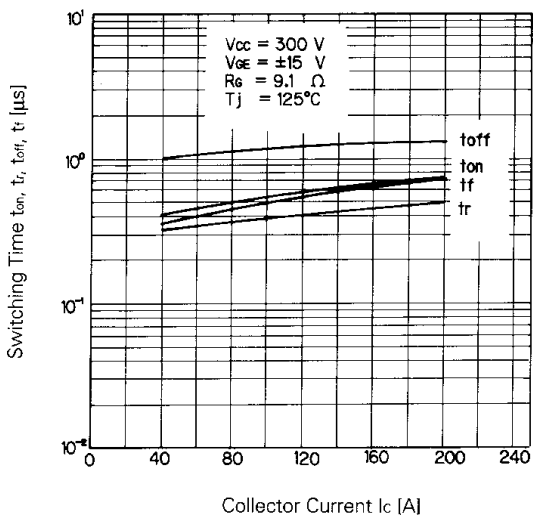

Switching Time

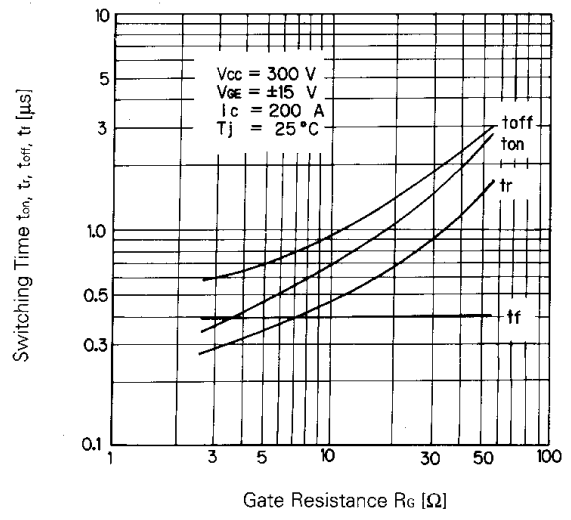

Switching Time-Gate Resistance

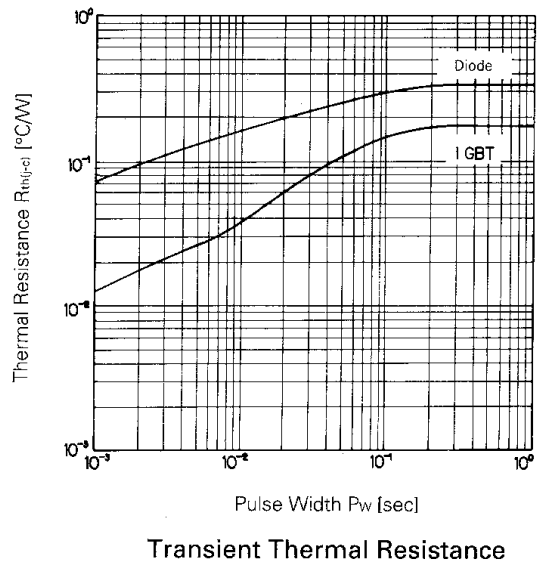
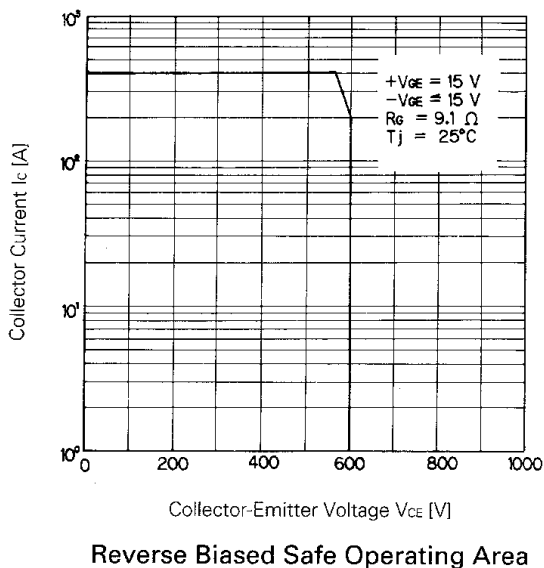
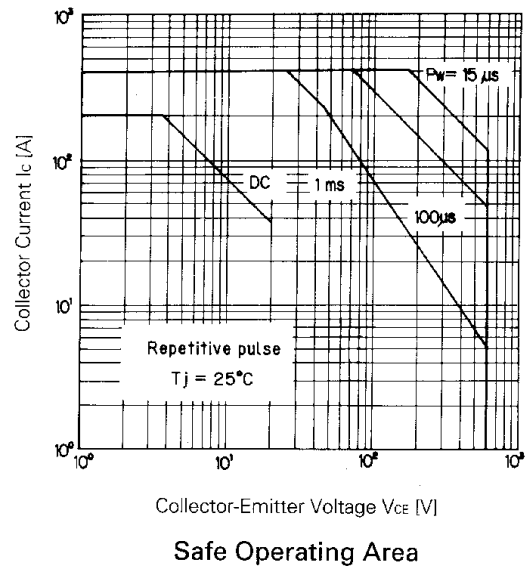
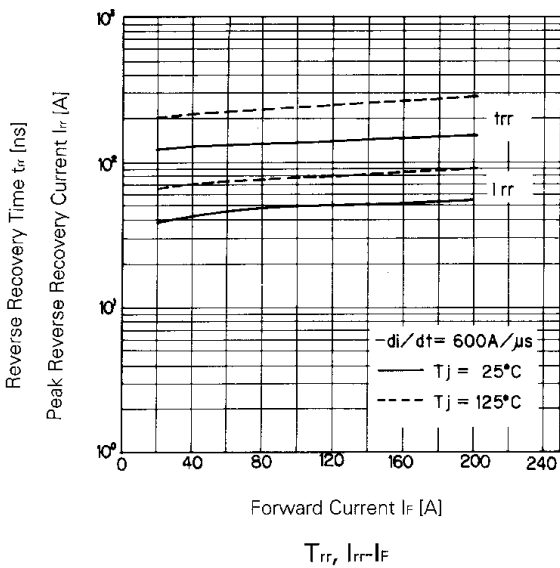
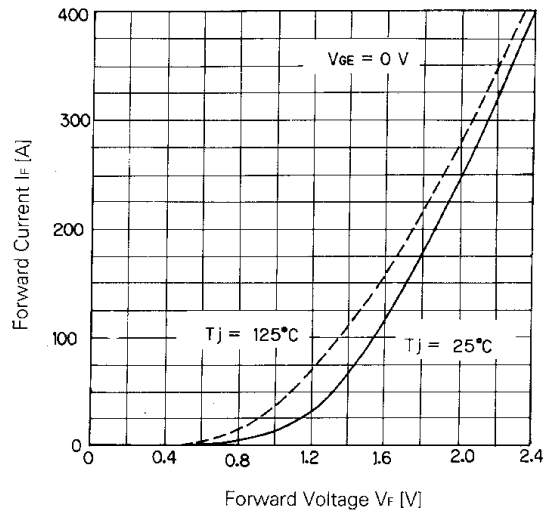
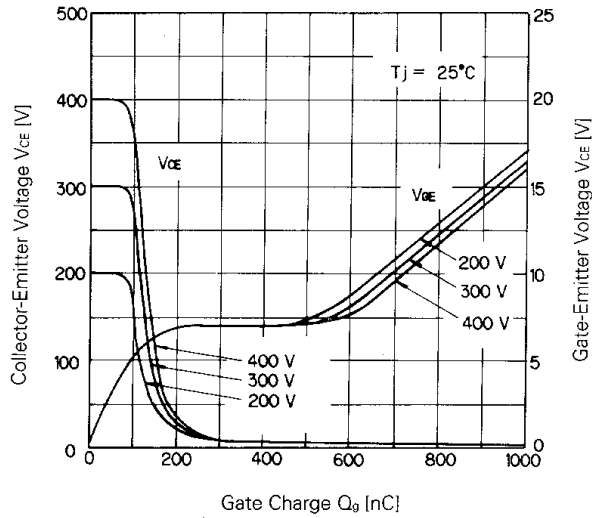

For more information, contact:

Collmer Semiconductor, Inc.

P.O. Box 702708

Dallas, TX 75370

972-733-1700

972-381-9991 Fax

<http://www.collmer.com>