

IGBT MODULE (N series)

■ Features

- Including Brake Chopper
- Square RBSOA
- Low Saturation Voltage
- Overcurrent Limiting Function
(~ 3 Times Rated Current)

■ Equivalent Circuit

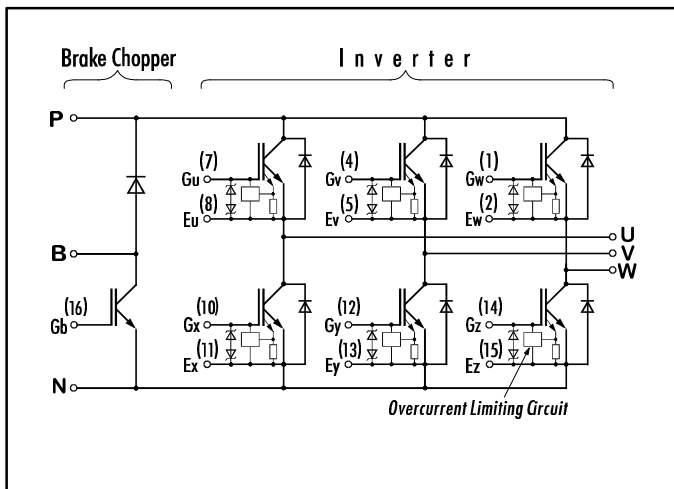

■ Outline Drawing

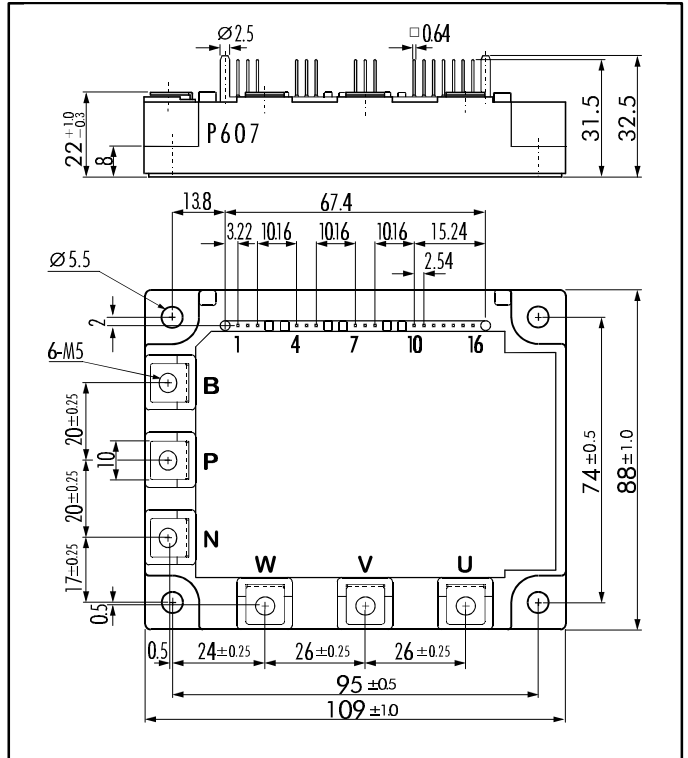

■ Absolute Maximum Ratings (T_c=25°C)

Items		Symbols	Test Conditions	Ratings	Units
Inverter	Collector-Emitter Voltage	V _{CES}		600	V
	Gate -Emitter Voltage	V _{GES}		± 20	
	Collector Current	I _C	Continuous	75	A
		I _{C PULSE}	1ms	150	
	Collector Power Dissipation	P _C	1 device	320	W
Brake Chopper	Collector-Emitter Voltage	V _{CES}		600	V
	Gate -Emitter Voltage	V _{GES}		± 20	
	Collector Current	I _C	Continuous	50	A
		I _{C PULSE}	1ms	100	
	Collector Power Dissipation	P _C	1 device	200	W
	Repetitive Peak Reverse Voltage	V _{RRM}		600	V
	Average Forward Current	I _{F(AV)}		1	A
Surge Current	I _{FSM}	10ms	50		
Operating Junction Temperature	T _j		+150	°C	
Storage Temperature	T _{Stg}		-40 ~ +125		
Isolation Voltage	V _{ISO}	A.C. 1min.	2500	V	
Mounting Screw Torque *1			3.5	Nm	
Terminal Screw Torque *1			3.5		

Note: *1:Recommendable Value; 2.5 ~ 3.5 Nm (M5)

■ Electrical Characteristics ($T_j=25^\circ\text{C}$)

		Items	Symbols	Test Conditions	Min.	Max.	Units
Inverter	IGBT	Zero Gate Voltage Collector Current	I_{CES}	$V_{GE}=0V$ $V_{CE}=600V$		3.0	mA
		Gate-Emitter Leakage Current	I_{GES}	$V_{CE}=0V$ $V_{GE}=\pm 20V$		15	μA
		Gate-Emitter Threshold Voltage	$V_{GE(th)}$	$V_{GE}=20V$ $I_C=75\text{mA}$	4.5	7.5	V
		Collector-Emitter Saturation Voltage	$V_{CE(sat)}$	$V_{GE}=15V$ $I_C=75A$		2.8	V
		Input capacitance	C_{ies}	$f=1\text{MHz}$, $V_{GE}=0V$, $V_{CE}=10V$		4950 (typ.)	pF
		Turn-on Time	t_{on}	$V_{CC}=300V$ $I_C = 75A$		1.2	μs
		Turn-off Time	t_{off}	$V_{GE}=\pm 15V$		1.5	
t_f	$R_G = 33\Omega$			0.35			
FWD	FWD	Diode Forward On-Voltage	V_F	$I_F=75A$ $V_{GE}=0V$		3.0	V
		Reverse Recovery Time	t_{rr}	$I_F=75A$; $V_{GE}=-10V$; $^{-dI/dt}=225$ $A/\mu\text{s}$		300	ns
Brake Chopper	IGBT	Zero Gate Voltage Collector Current	I_{CES}	$V_{GE}=0V$ $V_{CE}=600V$		1.0	mA
		Gate-Emitter Leakage Current	I_{GES}	$V_{CE}=0V$ $V_{GE}=\pm 20V$		100	nA
		Collector-Emitter Saturation Voltage	$V_{CE(sat)}$	$V_{GE}=15V$ $I_C=50A$		2.8	V
		Turn-on Time	t_{on}	$V_{CC}=300V$ $I_C = 50A$		1.2	μs
			Turn-off Time	t_{off}	$V_{GE}=\pm 15V$		
		t_f		$R_G = 51\Omega$		0.35	
		FWD	FWD	Reverse Current	I_{RRM}	$V_R=600V$	
Reverse Recovery Time	t_{rr}					600	ns

■ Thermal Characteristics

Items	Symbols	Test Conditions	Min.	Max.	Units
Thermal Resistance (1 device)	$R_{th(f-c)}$	Inverter IGBT		0.39	$^\circ\text{C/W}$
		Inverter FRD		0.90	
		Brake IGBT		0.63	
Contact Thermal Resistance	$R_{th(c-f)}$	With Thermal Compound	0.05 (typ.)		

Collector current vs. Collector-Emitter voltage
 $T_j=25^\circ\text{C}$

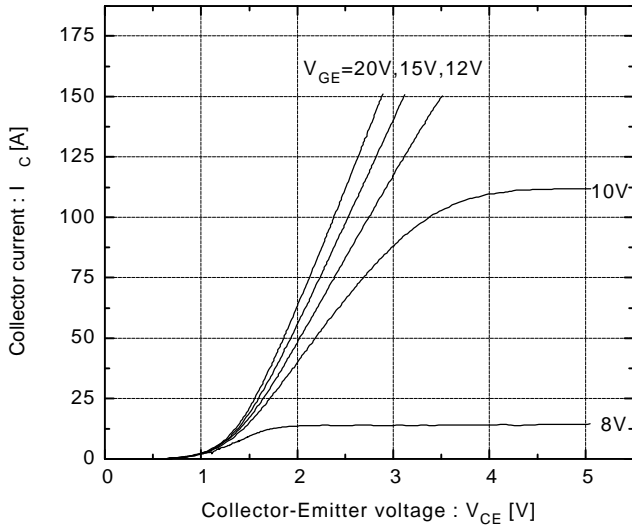

Collector current vs. Collector-Emitter voltage
 $T_j=125^\circ\text{C}$

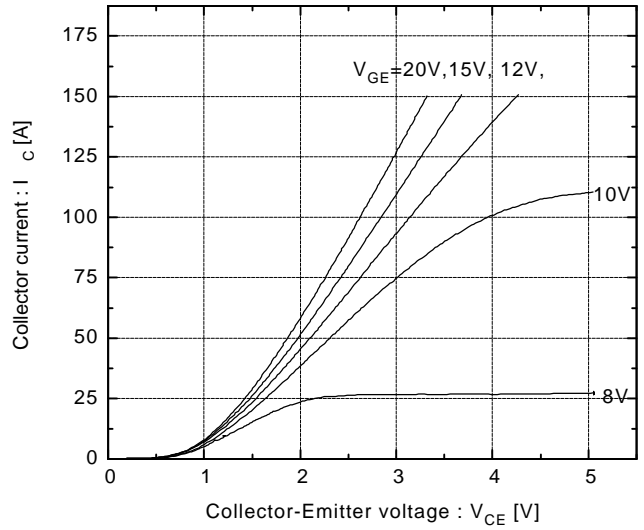

Collector-Emitter vs. Gate-Emitter voltage
 $T_j=25^\circ\text{C}$

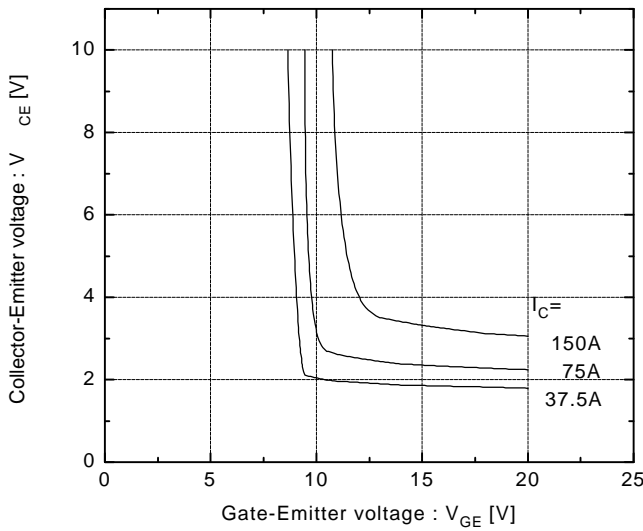

Collector-Emitter vs. Gate-Emitter voltage
 $T_j=125^\circ\text{C}$

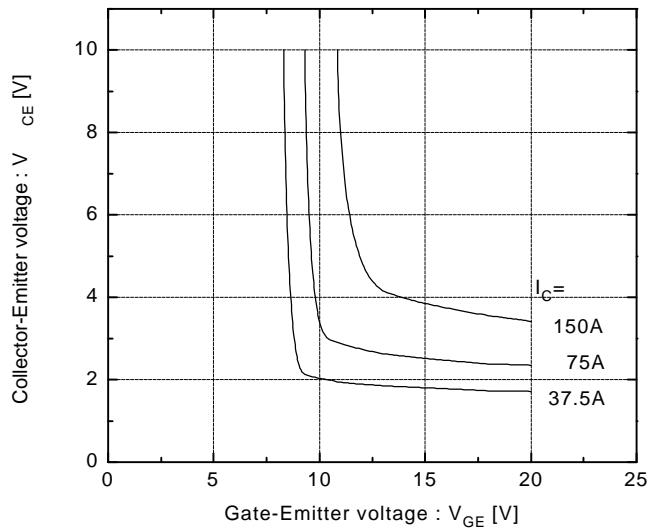

Switching time vs. Collector current
 $V_{CC}=300\text{V}, R_G=33\Omega, V_{GE}=\pm 15\text{V}, T_j=25^\circ\text{C}$

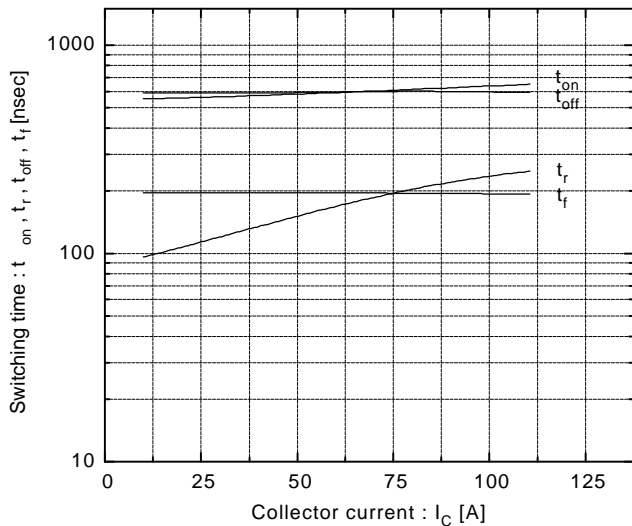

Switching time vs. Collector current
 $V_{CC}=300\text{V}, R_G=33\Omega, V_{GE}=\pm 15\text{V}, T_j=125^\circ\text{C}$

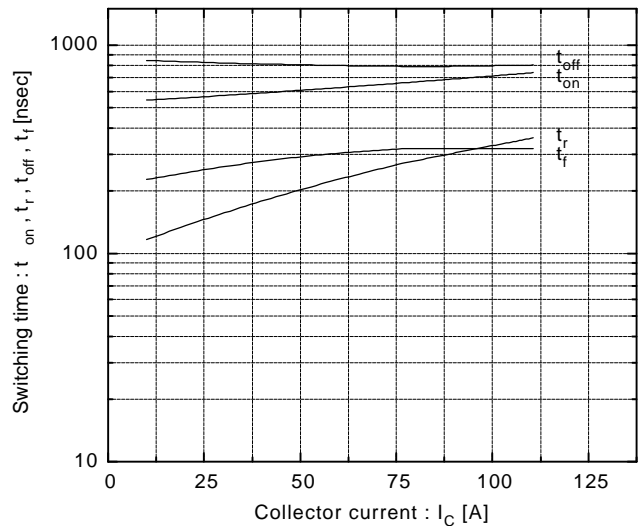

Switching time vs. R_G

$V_{CC}=300V, I_C=75A, V_{GE}=\pm 15V, T_J=25^\circ C$

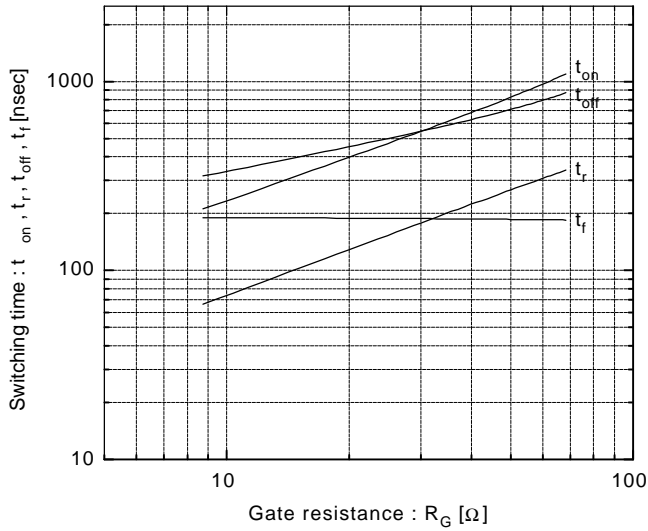

Dynamic input characteristics

$T_J=25^\circ C$

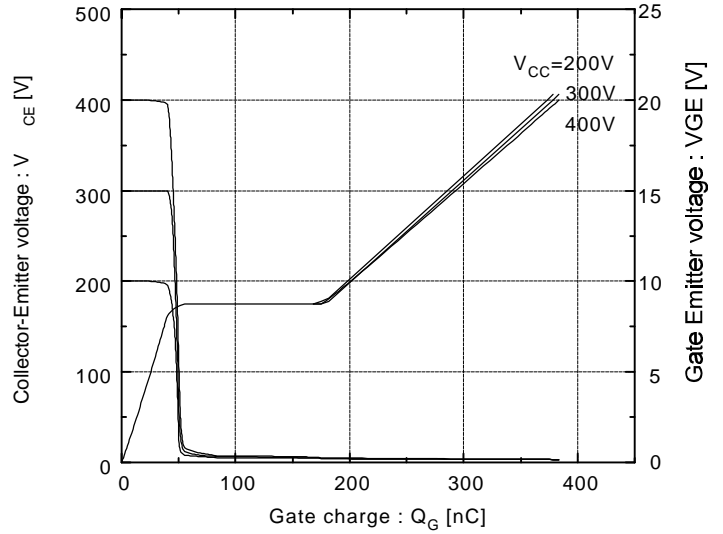

Forward current vs. Forward voltage

$V_{GE}=0V$

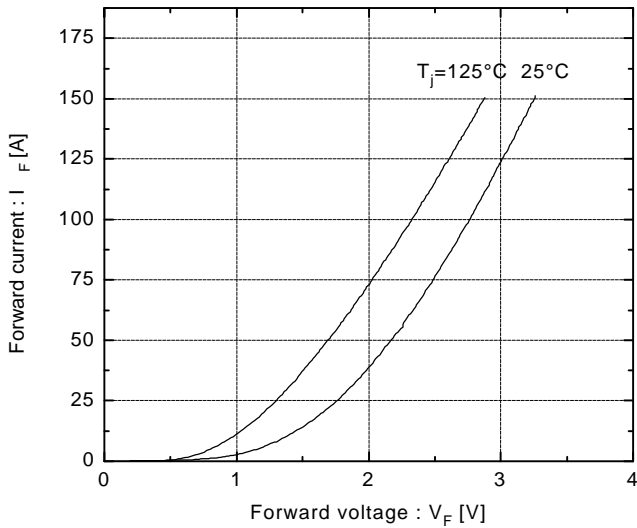

Reverse recovery characteristics

t_{rr}, I_{rr} vs. I_F

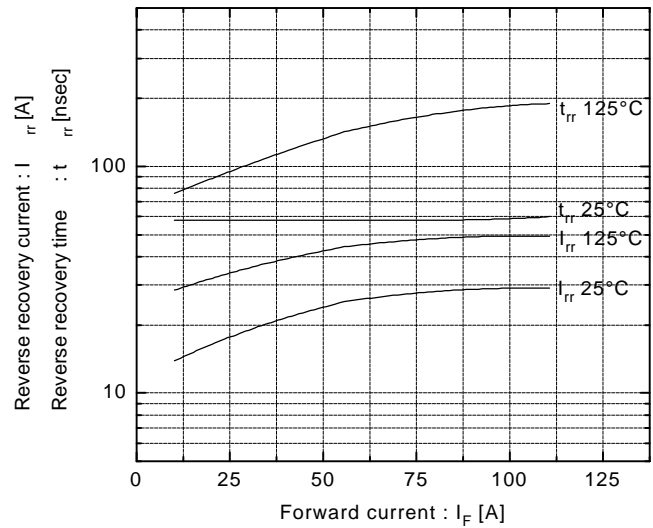

Transient thermal resistance

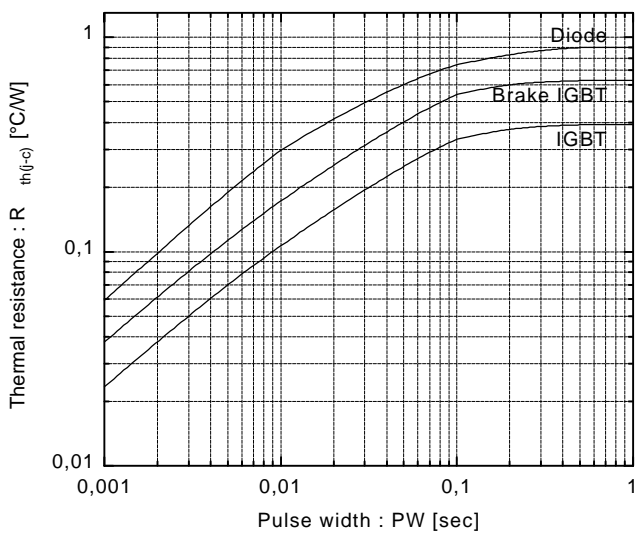

Reversed biased safe operating area

$+V_{GE}=15V, -V_{GE}\leq 15V, T_J\leq 125^\circ C, R_G\geq 33\Omega$

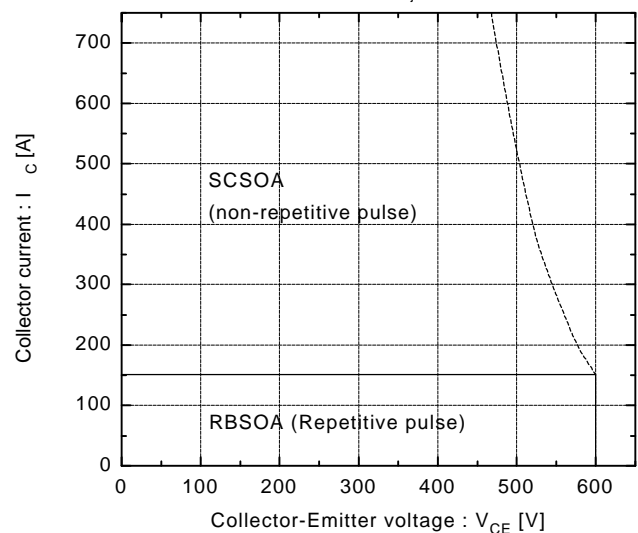

Switching loss vs. Collector current

$V_{CC}=300V, R_G=33\Omega, V_{GE}=\pm 15V$

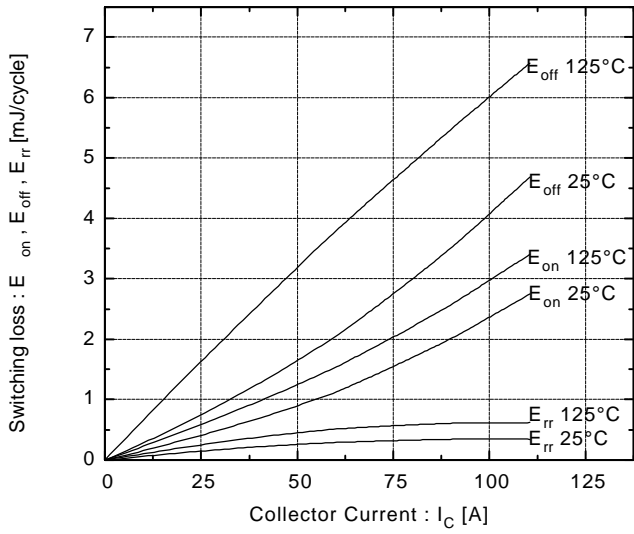

Capacitance vs. Collector-Emitter voltage

$T_j=25^\circ C$

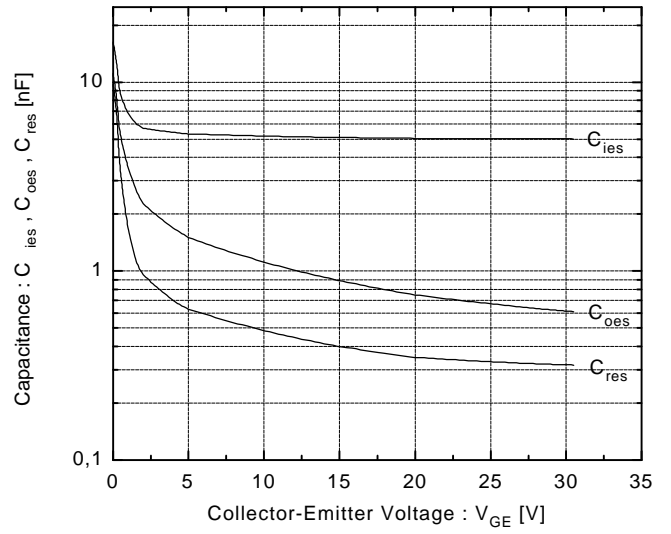

Brake Chopper IGBT

Collector current vs. Collector-Emittor voltage

$T_j=25^\circ\text{C}$

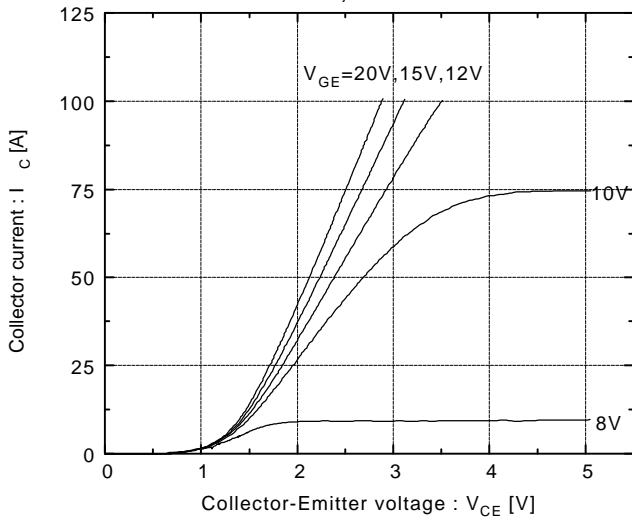

Collector current vs. Collector-Emittor voltage

$T_j=125^\circ\text{C}$

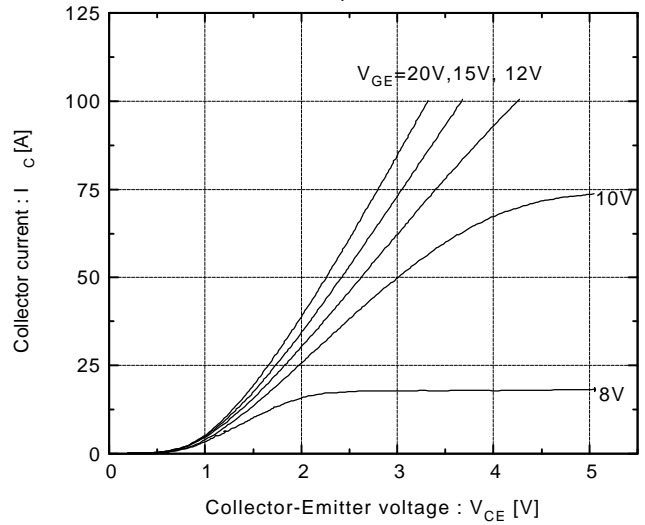

Collector-Emittor vs. Gate-Emittor voltage

$T_j=25^\circ\text{C}$

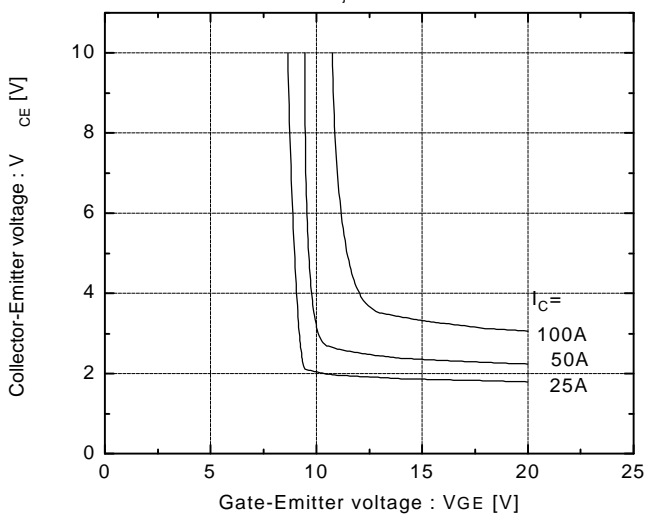

Collector-Emittor vs. Gate-Emittor voltage

$T_j=125^\circ\text{C}$

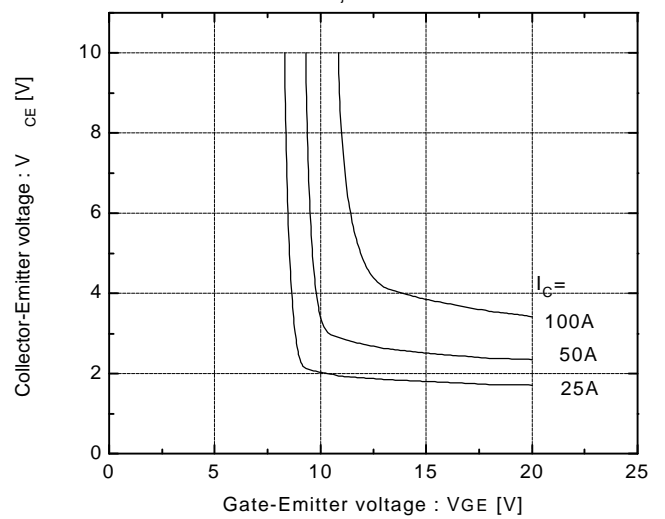

Switching time vs. Collector current
 $V_{CC}=300\text{V}, R_G=51\Omega, V_{GE}=\pm 15\text{V}, T_j=25^\circ\text{C}$

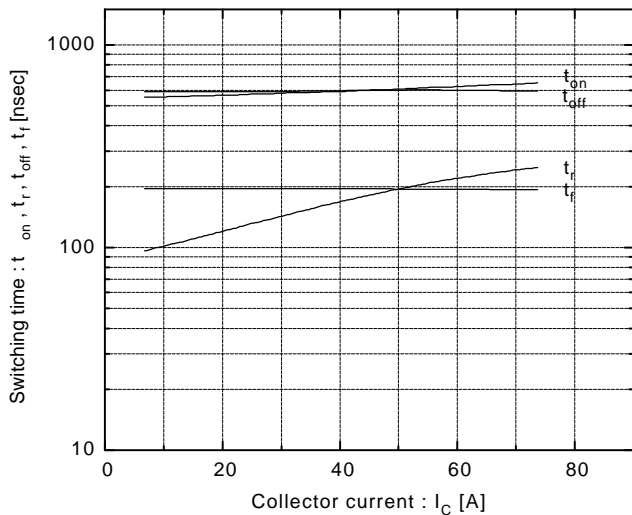

Switching time vs. Collector current
 $V_{CC}=300\text{V}, R_G=51\Omega, V_{GE}=\pm 15\text{V}, T_j=125^\circ\text{C}$

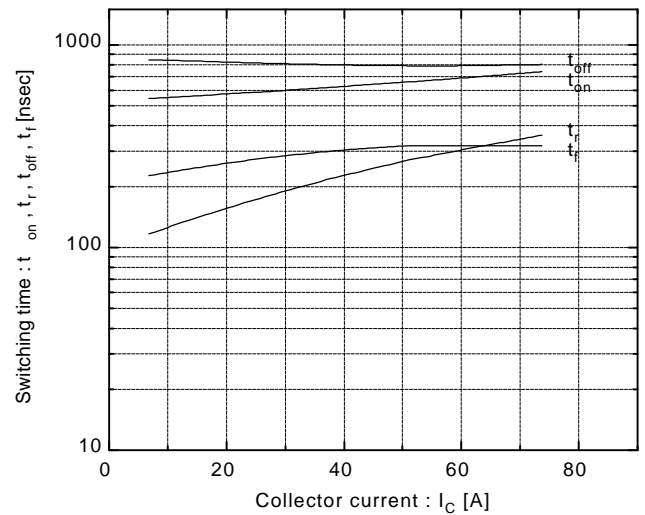

Brake Chopper IGBT

Switching time vs. R_G

$V_{CC}=300V, I_C=50A, V_{GE}=\pm 15V, T_J=25^\circ C$

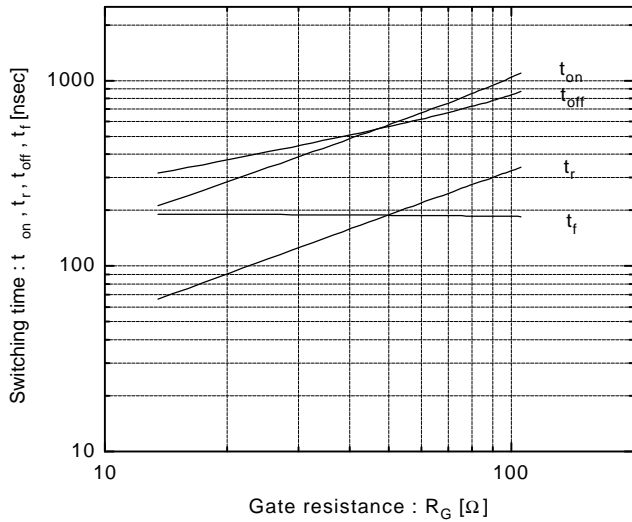

Dynamic input characteristics

$T_J=25^\circ C$

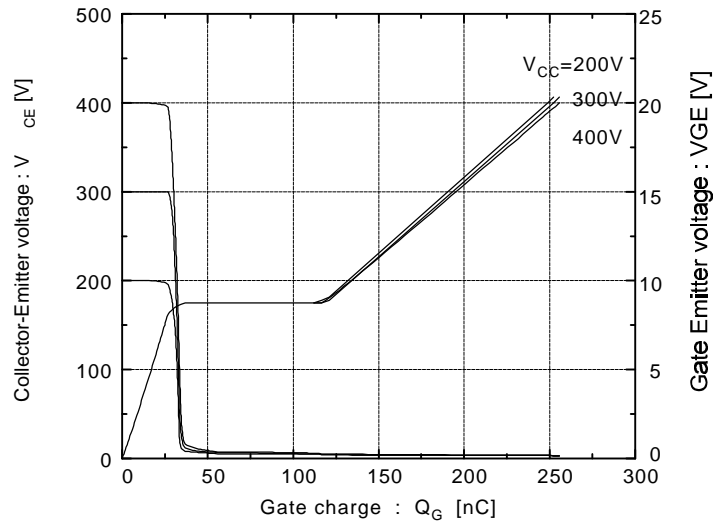

Reversed biased safe operating area
 $+V_{GE}=15V, -V_{GE}\leq 15V, T_J\leq 125^\circ C, R_G\geq 51\Omega$

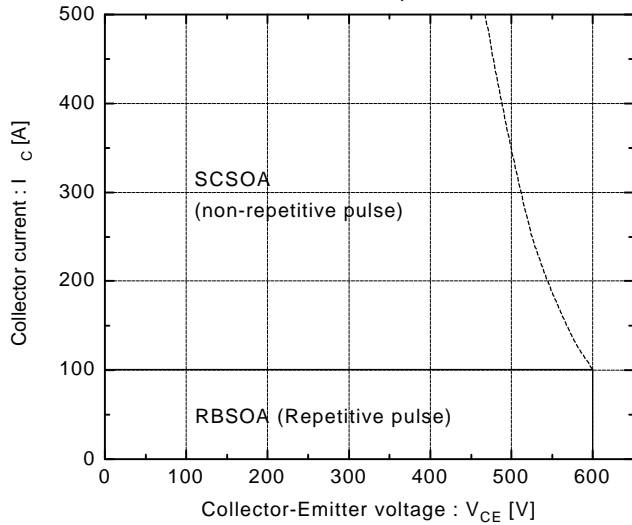

Switching loss vs. Collector current

$V_{CC}=300V, R_G=51\Omega, V_{GE}=\pm 15V$

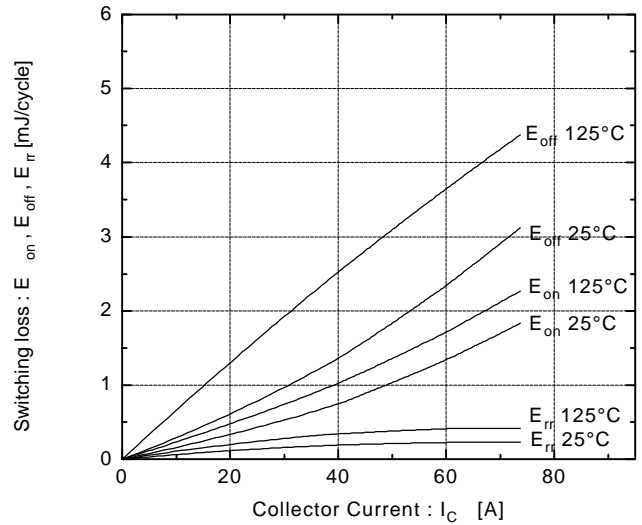

Capacitance vs. Collector-Emitter voltage

$T_J=25^\circ C$

